



OWNER'S MANUAL



CONTENTS

Introduction	3
Safety Precautions	3
Accessories	4
Other Required Items	4
About Trek	4
Glossary	5
Names and Functions of Parts	6
Operation	7
On Power Up	7
Description of Display Elements	8
Description of Buttons	9
Set-up Mode	11
Enabling Parameter Set-up Mode	11
Set-up Menu	11
Clock Menu	12
Water Tank Menu	13
New Battery Installation	16
Connectors	16
Installing Trek	16
Personnel	16
Installation Environment	16
Mounting	16
Trek to BatteryPlus35 Wiring	19
Water Tank Level Wiring	19
Servicing	20
Specifications	20
After-sales Service	20
Repairs and After-sales Service	20
Warranty Terms and Conditions	21

Copyright © Setec 2015

Disclaimer

Setec accepts no liability for any loss or damage, which may occur as a result of improper or unsafe use of its products. Warranty is only valid if the unit has not been modified by the customer and has not been misused.

Important Note: This product is only designed to work in conjunction with the BatteryPlus35 supply/charger. It will not interact with other products.

INTRODUCTION

SAFETY PRECAUTIONS

Please read the Safety Precautions carefully before installing the unit.



CAUTION

Failure to observe these instructions properly may result in property damage or personal injury, which may be serious depending on the circumstances.

Refer to the installation section before operating. Correct installation is the most critical factor in ensuring the safe use of the power supply. If every consideration of these instructions has been satisfied the power supply will be safe to operate.

As this unit is powered by a communication cable it is critical that all connections and cables are in a good and working order and properly connected.

Do not allow water or other liquids to enter the installation area.

ACCESSORIES

The following accessories are provided with the retail pack for this product.

- › A Trek Unit
- › Front Fascia Plate
- › Data Cable 10m
- › Tank Loom
- › Trek Manual

OTHER REQUIRED ITEMS

- › 4 counter sunk screws for mounting, refer to Installing Trek for more details.

ABOUT TREK

The Trek is a display and control unit that connects to BatteryPlus35 and displays a range of battery and water tank information. Its backlit LCD displays information including:

- › Battery voltage
- › Battery charging and discharging currents
- › Auxiliary and solar charging currents
- › Battery charge status
- › Time remaining to discharge
- › Level indication of up to 4 water tanks
- › Time am/pm
- › Water pump status
- › Battery on/off status

Features also include:

- › z which can be set as a night light
- › Button to control 2 water pumps through BatteryPlus35
- › Button to disconnect the battery from the loads

The above information is retrieved from BatteryPlus35 via the communication bus.

GLOSSARY

Loads

Consists of any appliance connected to the output terminal of the batteryPlus35 including lights, TV, radio, etc.

Sources

Consists of any device that can supply power to BatteryPlus35 and its loads, such as solar input, battery input, aux input and AC input.

Communication Bus

BatteryPlus35 and Trek are connected via a data cable and the communication between the two devices is referred to as a communication bus.

BatteryPlus35

Integrated battery charger and power supply that converts 240VAC, Solar or Auxiliary DC power to 12V DC which powers loads or charges a battery.

NAME AND FUNCTION OF PARTS

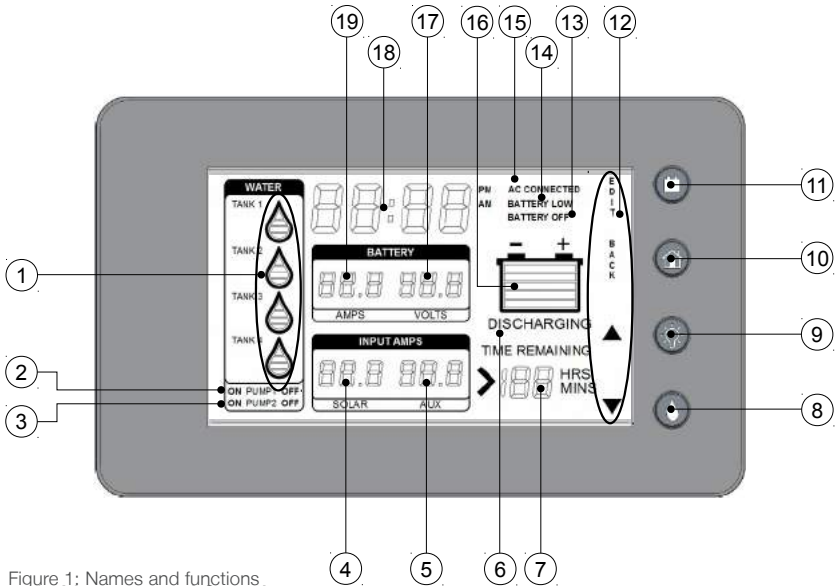

Figure 1: Names and functions.

- | | |
|---|---|
| <p>① Tank 1 / Tank 2 / Tank 3 / Tank 4
Water tank level indicators. These can also be turned into waste water tanks</p> <p>② Pump1 Status Indicator</p> <p>③ Pump2 Status Indicator</p> <p>④ Solar Current</p> <p>⑤ Aux Current</p> <p>⑥ Battery Charge State
This shows if the battery is charging or discharging</p> <p>⑦ Time Remaining
Time remaining for the battery to charge or discharge</p> <p>⑧ Water Pump Button
This button turns the pumps on and off</p> <p>⑨ Back-light Button</p> <p>⑩ Home Button
Home button is used for set-up functions</p> | <p>⑪ Battery Isolate Button
When paired with a BatteryPlus35, this switch will isolate the battery from the loads</p> <p>⑫ Set-up Mode Indicators
These indicators only appear when in setup mode</p> <p>⑬ Battery Off
Appears only when ⑪ the Battery isolate button is pushed</p> <p>⑭ Battery Low
Appears only when Battery voltage is less than 11V. This is set in the Battery alarm menu</p> <p>⑮ AC Connected</p> <p>⑯ Charge Bar Graph</p> <p>⑰ Battery Voltage</p> <p>⑱ Clock</p> <p>⑲ Battery Current</p> |
|---|---|

OPERATION

In normal power-on mode the unit displays the Home screen.

Trek is designed to interface with BatteryPlus35. The functionality described below assumes Trek has been correctly connected to BatteryPlus35.

The Trek will turn off if the battery voltage is less than 10.5V.

ON POWER UP

On Power up Trek will display "CAN WAIT" until communication between Trek and BatteryPlus35 is established.

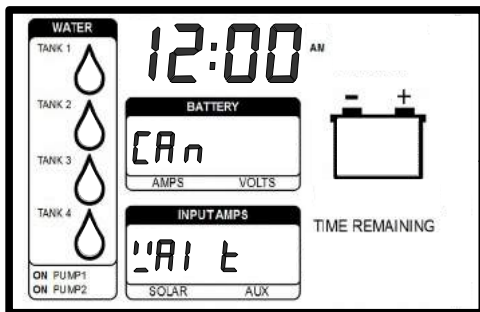

Figure 2: Trek display when first powered up

When communication between Trek and BatteryPlus35 is established, Trek will display information similar to the Figure 3.

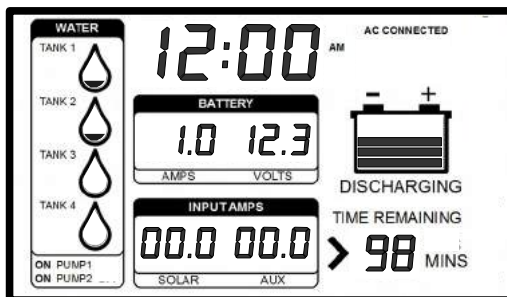

Figure 3: Trek displaying information after initial power on, typical home screen

If Trek cannot establish this communication within 30 seconds, then "CAN Err To" will be displayed. If this occurs then, there is a fault in the system. Check all connections.

DESCRIPTION OF DISPLAY ELEMENTS

Tank1 / Tank2 / Tank3 / Tank4 ①

Trek can support up-to 4 tank sensors and can be set-up as fresh water and/or waste water tanks. By default, only Tank 1 and Tank 2 are set-up, as fresh water tanks. These indicate the approximate water level in each of the tanks.

Fresh water tank

When the tank is installed and set-up as a fresh water tank, all 4 level segments are shown when the tank is full.

Only the bottom level segment flashes and the other segments are not shown when the tank is nearing empty or empty.

If a tank is not installed, that particular tank indicator will have no level segments shown.

Waste Water Tank

Water tanks can be set as waste water tanks, refer to the Water Tank Menu.

When a tank is set-up as waste water tank, all 4 level segments are shown and will be flashing if the tank is full. When empty, only the bottom level segment is shown.

Pump Status Indicator ② ③

These indicators show if the pumps installed are on or off. This is controlled by the pump button ⑧.

Solar Charge Current ④

This is the current that is drawn when the solar charger in BatteryPlus35 is active.

Aux Charge Current ⑤

Refers to the current that is drawn when the Aux in BatteryPlus35 is active.

Battery Charge State ⑥ ⑬

A multi-segmented bar graph showing the state of charge of the battery. Below the bar graph is displayed the word "CHARGING" or "DISCHARGING" according to the charging state of the battery.

Time Remaining ⑦

Indicates the estimated time remaining for the battery to be charged to full or, discharged to empty, assuming it continues to charge/discharge at the current rate. If the remaining time is greater than 199 hours, the display shows ">199 HRS" and the battery is neither charging nor discharging, the display is blank.

Set-up Mode Indicators ⑫

These indicators only appear when Trek is in set-up mode. The icons indicate the functions of the buttons adjacent to it. The icons include edit, back, and symbol.

Battery Off ⁽¹³⁾

This indicator is only displayed when loads are disconnected from all sources including the battery. This is controlled by the battery isolate button . All other segments will also be turned off to reduce current draw from the battery.

Battery Low ⁽¹⁴⁾

This indicator shows when the battery voltage is at or below 11.0 Volts. It is recommended to charge the battery at this point.

This is user configurable, refer to the Set-up Mode section.

AC connected ⁽¹⁵⁾

This indicator appears only when BatteryPlus35 is connected to AC mains.

Volts ⁽¹⁷⁾

Displays the battery voltage.

Amps ⁽¹⁹⁾

Shows the charging or discharging current of the battery.

Clock ⁽¹⁸⁾

Displays a 12 or 24 hour clock. This is user configurable. Refer to the Set-up Mode section.

DESCRIPTION OF BUTTONS

Water Pump Button ⁽⁸⁾

This button controls power to the water pump outputs on BatteryPlus35.

When BatteryPlus35 and Trek are first powered, the outputs assigned for the pumps are ON and Trek display "ON PUMP1" ⁽²⁾ and "ON PUMP2" ⁽³⁾.

Pump1

To switch pump1 On/Off press the water pump button ⁽⁸⁾ once.

Pump2

To switch pump2 On/Off press and hold pump button ⁽⁸⁾ until the desired change is seen.

In set-up mode the water pump button turns into the "button".

Back-light Button ⁽⁹⁾

Back-light button is primarily used to enable the back-light.

In set-up mode the back-light button is the " button".

Back-light Functionality

Turn on back-light temporarily: Press any button to turn ON the back-light temporarily and will automatically turn off after 30 seconds.

Turn on night-light: Press and hold the back-light button until the back-light blinks (approximately three seconds). The back-light will turn ON for 10 hours.

Turn off night-light: Press and hold the back-light button until the back-light is OFF.

Home Button ⑩

Pressing and holding the Home button for approximately 5 second puts Trek into the set-up mode.

In set-up mode the home button is the “back button”.

Battery Button ⑪

The battery button is used to disconnect the battery, AC mains, auxiliary and solar sources from the loads.

When Trek is first turned on the battery will power the loads and “BATTERY OFF” ⑬ is NOT displayed. When the battery button is pressed, the loads are disconnected from the battery and “BATTERY OFF” will appear and all other segments will also be turned off to reduce current draw from the battery.

Pushing the battery button will toggle the loads ON and OFF.

In set-up mode the battery button is the “EDIT button”.

SET-UP MODE

ENABLING PARAMETER SET-UP MODE

1. Ensure the display is in normal mode (not in any setting mode).
2. Press and hold the Home button for at least 5 seconds.
3. "SETUP" will be displayed in (17) (19) location.
4. Now you are in set-up mode.

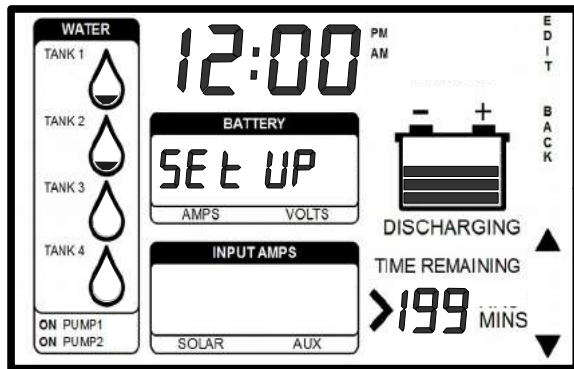

Figure 4: Set-up Mode

When in set-up mode, the "or" button can be used to scroll through the setup menu. The list of options in the set-up menu is as follows:

Mode: SET UP	▲	CLOCK	Clock Menu
	▲	TANK HS	Water Tank Menu
Click "EDIT" to select required Category	▲	BATCAP	Battery Capacity Menu
	▲	BATALM	Battery Alarm Menu
	▲	BAHLT	LCD Back-light Menu
	▲	PUMP	Pump output select Menu
	▲	SWER	Trek software Version, Read ONLY
	▲	BPuEr	BatteryPlus35 software version, Read ONLY
	▲	FACTrY	Factory Reset

CLOCK MENU

When in set-up mode use the following.

Set-up 12hr Clock

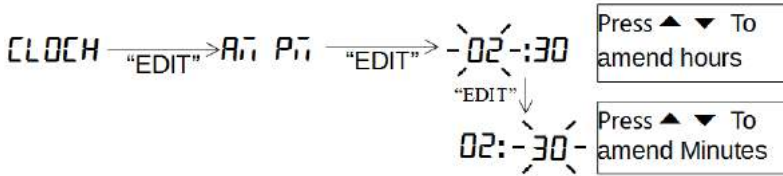

AM and PM annunciators will automatically change as the time changed from 11 to 12. To exit, keep pressing the "Back" button until the home screen is seen.

Set-up 24hr Clock

To exit, keep pressing the "Back" button until the home screen is seen.

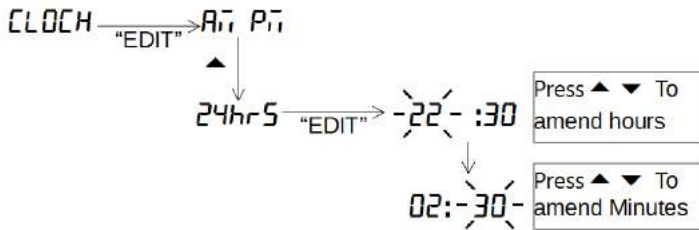

WATER TANK MENU

To exit the menu, keep pressing the “Back” button until the home screen is seen.

Water Tank Enable

This shows how to enable or disable the water tanks.

After enabling the required tank, allow for 15 seconds for the tank levels to update.

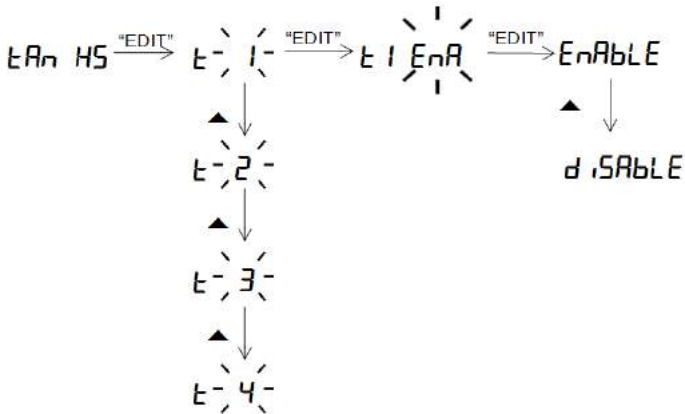

Water Tank Method

This shows how to choose the water tank method. It allows the installer to choose the type of sensing depending on the sensor used, analog or digital.

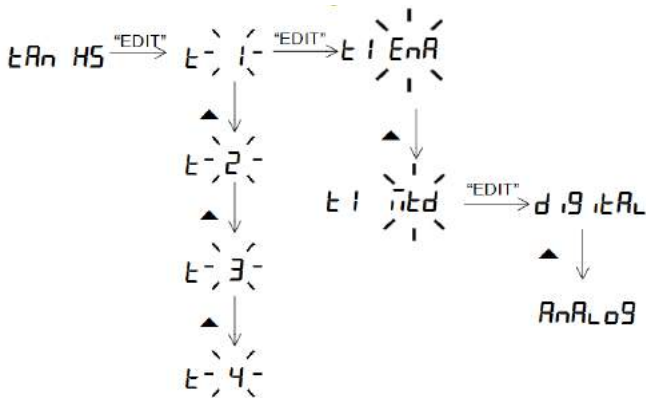

Water Tank Type

This shows how to change the water tank from a fresh water to waste water tank.

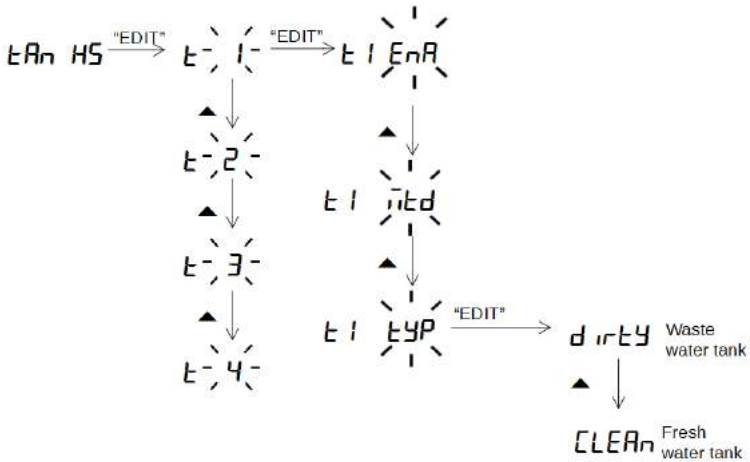

Battery Capacity Menu

This shows how to change the battery capacity in AH. The battery capacity can be incremented or decremented.

When a new battery is fitted, set this to the nominal battery capacity (as marked on the battery); doing this will assist the software in determining the actual capacity.

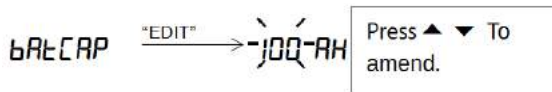

Battery Alarm Menu

This shows how to change the battery alarm. This parameter indicates when the Battery Low ⁽¹⁴⁾ annunciator starts to blink. The alarm threshold can be incremented or decremented in steps of 0.5V. The alarm threshold can be adjusted from 10.5V to 12.5V.

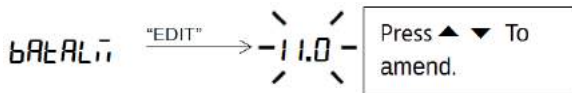

LCD Back-light Menu

This shows how to change the LCD back-light brightness. The back-light brightness can be incremented or decremented in steps of 10%. The brightness can be adjusted from 10% to 100%.

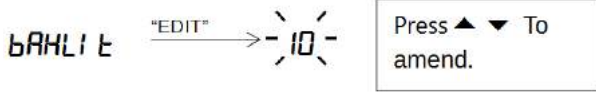

Factory Reset Menu

This shows how to restore Trek back to factory settings.

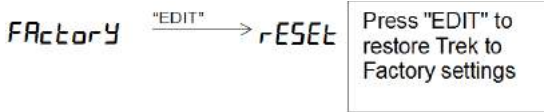

WARNING: All saved settings will be erased.

NEW BATTERY INSTALLATION

Trek is a smart battery monitor that is able to learn the actual battery capacity and thus provide more accurate “Time Remaining” feedback to the user. When an existing battery is replaced by a new one, check the capacity of the new battery verify this in Battery Capacity Menu on page 4. Change this as required.

Fitting a new battery and doing nothing else will result in the “Time Remaining” display initially being inaccurate. It is recommended to charge the battery until Trek shows its full for a better accuracy reading.

See BatteryPlus35 installation instructions for more information on the installation of new battery.

CONNECTORS

At the rear of Trek are two connectors.

1. The communication bus connector which is a data cable that connects BatteryPlus35 to Trek.
2. The Tanks Sensor connector with a detachable loom. This loom can be connected to 4 digital tank sensors.

Note: The digit '1' is moulded into the rear of Trek case beside each connector, indicating the location of pin 1.

INSTALLING TREK

PERSONNEL

Installation is to be carried out only by suitably qualified personnel.

INSTALLATION ENVIRONMENT

Trek should be installed indoors where it will not be subject to water or other liquid spills or splashes.

MOUNTING

Trek is designed to be mounted to the wall directly with counter sunk screws. It can be mounted in two methods depending on the look and application required. The mounting methods and required mounting holes are specified below. The cut-outs below each method are also to allow space for connectors at the back of Trek. These cut-outs are to scale and can be used to cut the hole in the wall before fixing the unit.

After fixing Trek to the wall attach the provided front fascia plate to Trek. This fascia clips on to the front of Trek.

Screw requirement for mounting method 1:

Screw type: Counter sunk

Diameter: 4.0mm Max

Length: 25mm Min

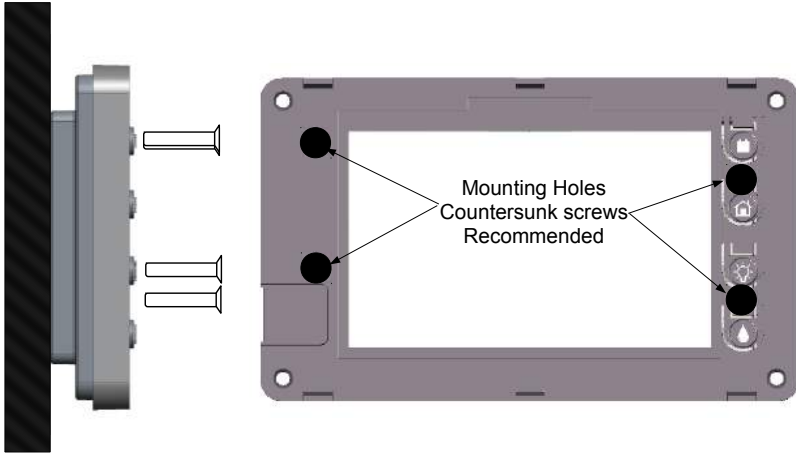

Figure 5: Mounting Method 1 Details

Screw requirement for mounting method 2:

Screw type: Counter sunk

Diameter: 3.5mm Max

Length: 20mm Min

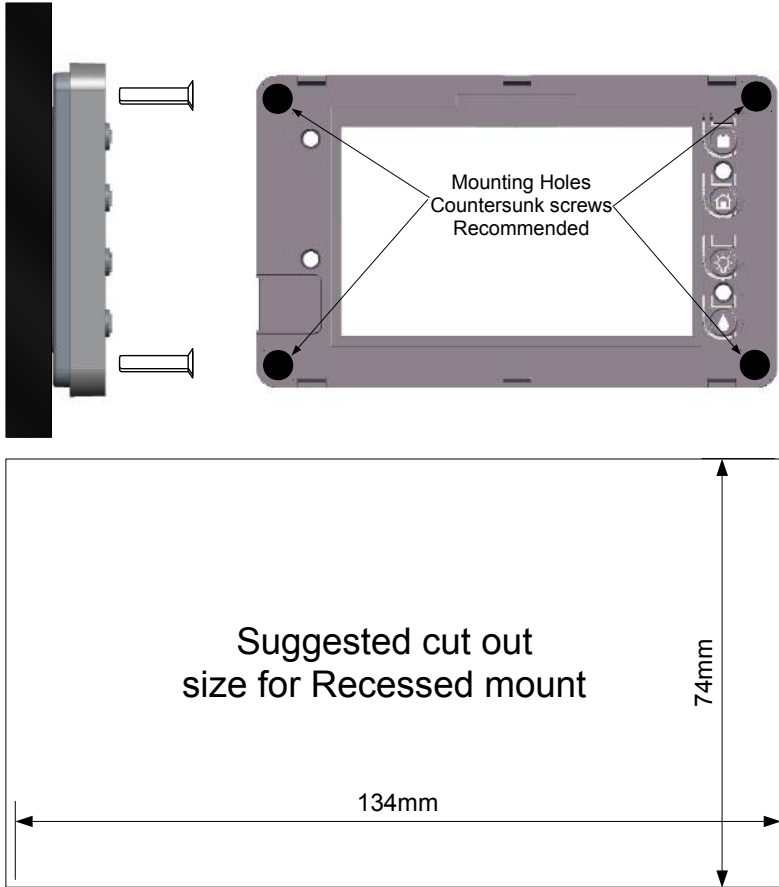

Figure 6: Mounting Method 2 (RECESS) Details

TREK TO BATTERYPLUS35 WIRING

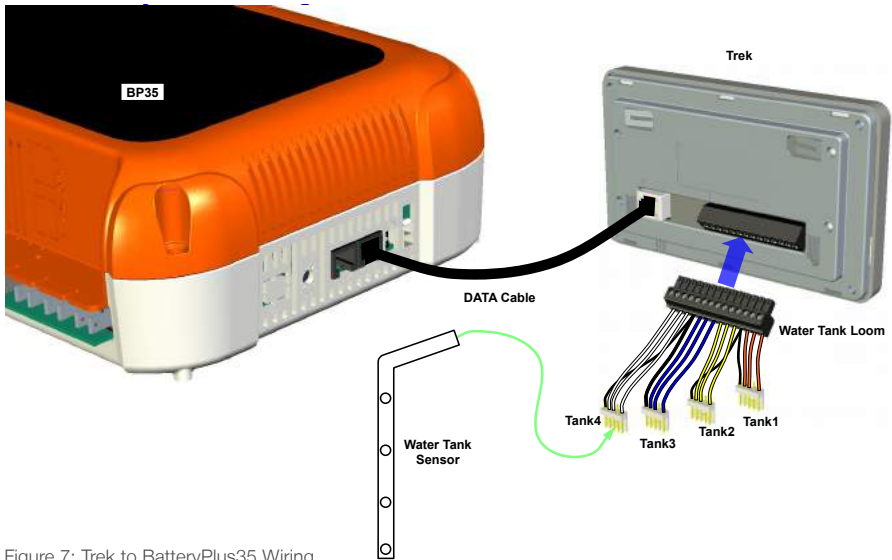

Figure 7: Trek to BatteryPlus35 Wiring

WATER TANK LEVEL WIRING

Digital Sensor

1. Empty the water from the tank(s)
2. Choose a suitable side of the tank where the level-sensing bungs can be located.
3. Drill the required holes in the tank
4. Install the tank sensor to the tank
5. Connect sensor connector to the water tank loom
6. Fill the tank(s) and check for water leaks around the bungs. Reseal as necessary.
7. Test operation of water level sensors, water pump switch, and Battery on/off switch.

SERVICING

There are no internal user serviceable parts

SPECIFICATIONS

Specification	
Input Voltage	8 – 15 Vdc
Battery Drain	< 21 mA (backlight off)
Ambient Temperature	0 °C – 50 °C
Size	149 Wide x 85 High x 22 Deep

AFTER-SALES SERVICE



WARNING Do not disassemble, modify, or repair the unit. Doing so may result in electric shocks or fire.

REPAIRS AND AFTER-SALES SERVICE

Consult your BM PRO by Setec dealer.

TROUBLE-SHOOTING

Trek not responding; If the Trek seems to have stopped responding while pressing buttons, wait for 30 seconds and the Trek will reset and resume operation.

WARRANTY TERMS AND CONDITIONS

Registering your BM PRO by Setec product is an important step to ensure that you receive all of the benefits you are entitled to. Please visit www.teambmpro.com to complete the online registration form for your new product today.

1. BM PRO by Setec goods come with guarantees that cannot be excluded under Australian Consumer Law. You are entitled to a replacement or refund for major failure and for compensation for any reasonably foreseeable loss or damage. You are entitled to have the goods repaired or replaced if the goods fail to be of acceptable quality and the failure does not amount to a major failure. The benefits under this Warranty are in addition to your other rights and remedies under a law in relation to the goods to which this Warranty relates (the Australian Consumer Law).

2. Setec, as the manufacturer of BM PRO by Setec goods warrants products against defects for a period of two years, commencing from the original date of purchase. Proof of purchase is required before you can make a claim under this warranty.

3. HOW TO PROTECT YOUR RIGHTS UNDER THIS WARRANTY: Trek is designed to be installed by a suitably qualified installer. You or your installer should carefully inspect the product before installation for any visible manufacturing defects. We accept no responsibility in addition to our consumer guarantee obligations where a product has been installed incorrectly.

4. This warranty does not extend to product failures or defects caused by, or associated with, but not limited to; failure to install or maintain correctly, unsuitable physical or operating environment, accident, acts of God, hazard, misuse, unauthorised repair, modification or alteration, natural disaster, corrosive environment, insect or vermin infestation and failure to comply with any additional instructions supplied with the product.

5. Setec may seek reimbursement of any costs incurred by them when a product is found to be in proper working order or damaged as a result of one or more of the warranty exclusions mentioned in point 4 of this statement.

6. To enquire or make a claim under this warranty, please follow these steps:

- a. Prior to returning a BM PRO by Setec product, please email warranty@teambmpro.com to obtain a Return Material Authorisation (RMA) number
- b. Package and send the product to: BM PRO by Setec Warranty Department, 19 Henderson Road, Knoxfield, VIC 3180. Please mark RMA details on the outside of the packaging
- c. Please ensure the package also includes: a copy of the proof of purchase, a detailed description of the fault and your contact details including phone number and return address

7. Setec will not be liable for any costs, charges or expenses incurred in the process of returning a product in order to initiate a warranty claim



THE BM PRO BATTERYCHECK



The BatteryCheck is an easy to install device that sets a new standard in battery management systems. This innovative product connects to your deep cycle battery and communicates wirelessly with smart phones. The BatteryCheck provides real time battery management data that allows you to effectively manage remaining battery energy via a simple to use app.

Key features

- > Communicates via Bluetooth with smart phones
- > Free downloadable app via Google Play and App Store
- > Instant real time data - view information including volts and amps, time remaining, temperature, battery status, state of charge and battery health
- > Easy installation – no mechanical expertise required
- > Works with multiple batteries when in parallel (7Ah-800Ah Battery Bank)
- > Internal shunt capacity - 80 amps continuous
- > Set automatic alarm warnings via app
- > Compatible with any deep cycle 12 or 24V Lead Acid, AGM and Gel 7Ah-800Ah battery

**A WORLD FIRST, INNOVATION
PATENTED PRODUCT SHOWCASING
THE LATEST TECHNOLOGY IN
WIRELESS BATTERY MANAGEMENT**



BM PRO - 19 Henderson Road, Knoxfield 3180, Victoria, Australia
Phone +61 3 9763 0962 | Fax +61 3 9763 8789
Email sales@teambmpro.com | Web www.teambmpro.com

SWITCH OFF. POWER UP